

A x8 7x50mm	B x16 8x32mm	C2+D x2 B/D	C3+D x4 W/D	E x19 3,5x13mm	E2 x12 3x20mm	EP1 x20 4x16mm	H1 x10 	M x3 L=150mm
N1 x5 20x20 / H=150mm	P x12 	R x8 H=11mm	U x8 L=24,3mm	W1 x1 	XA x1 	ZA x8 ∅4	ZR x8 ∅15	

C-1	1531	395	16	x 1	1/2
C-2	1531	395	16	x 1	1/2
C-3	632	394	16	x 1	1/2
C-4	632	394	16	x 1	1/2
C-5	632	347	16	x 1	1/2
C-6	632	347	16	x 1	1/2
C-7	492	335	16	x 2	1/2
C-8	482	335	16	x 1	1/2
C-9	496	626	18	x 2	2/2
C-10	496	626	16	x 1	2/2
C-11	1512	646	3	x 1	1/2

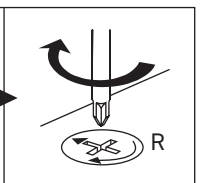

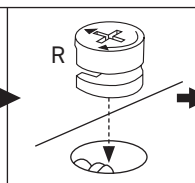
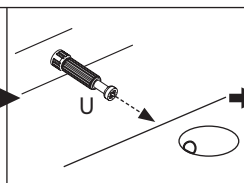
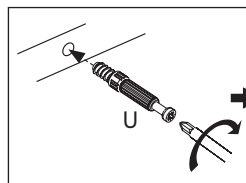
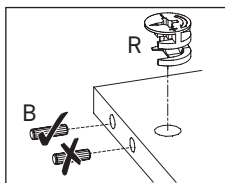
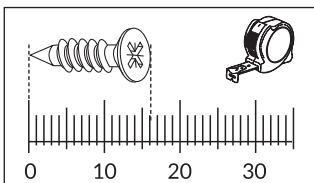
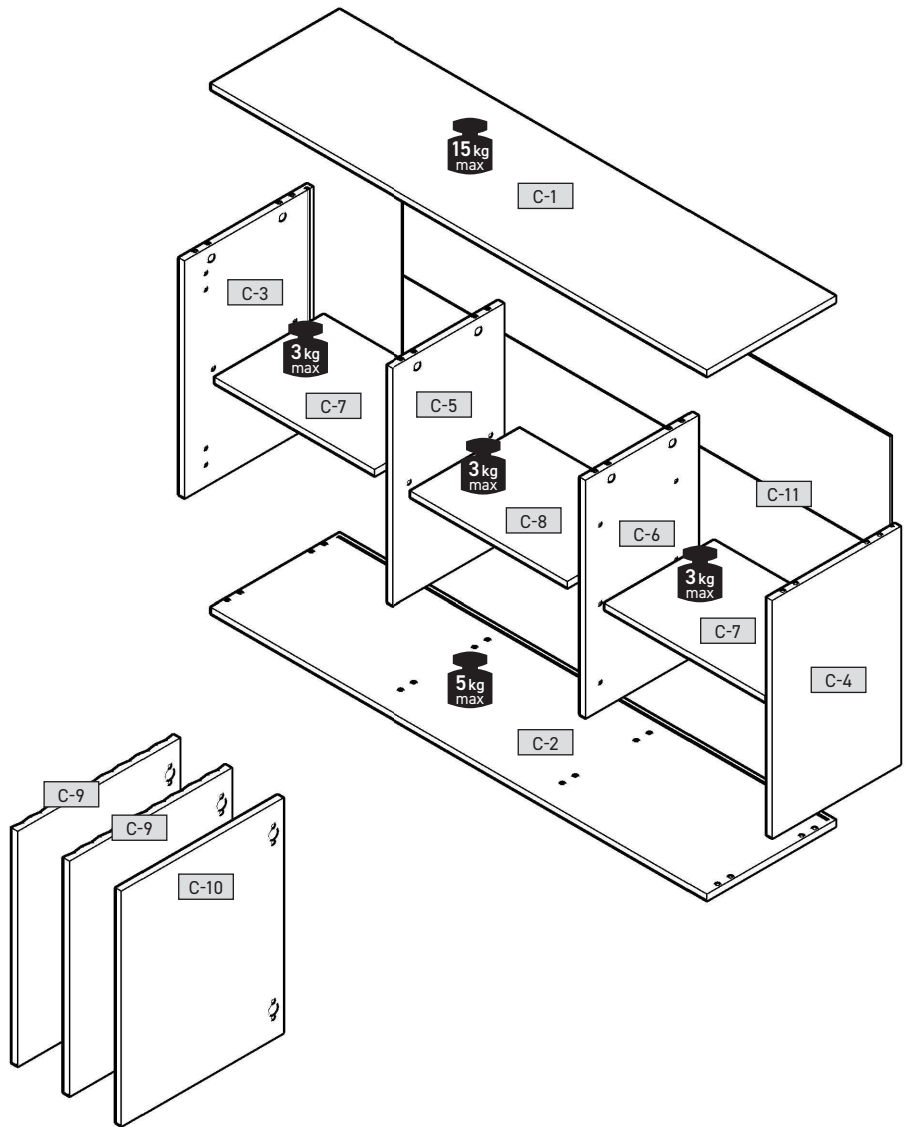
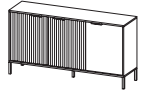

1

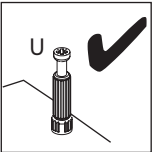
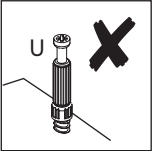
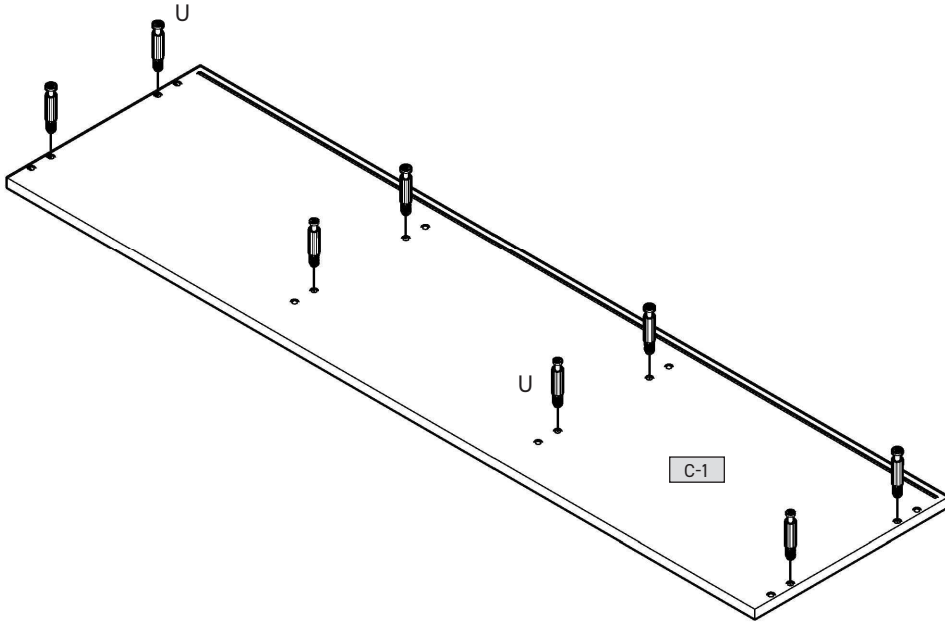
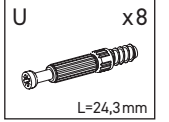

2

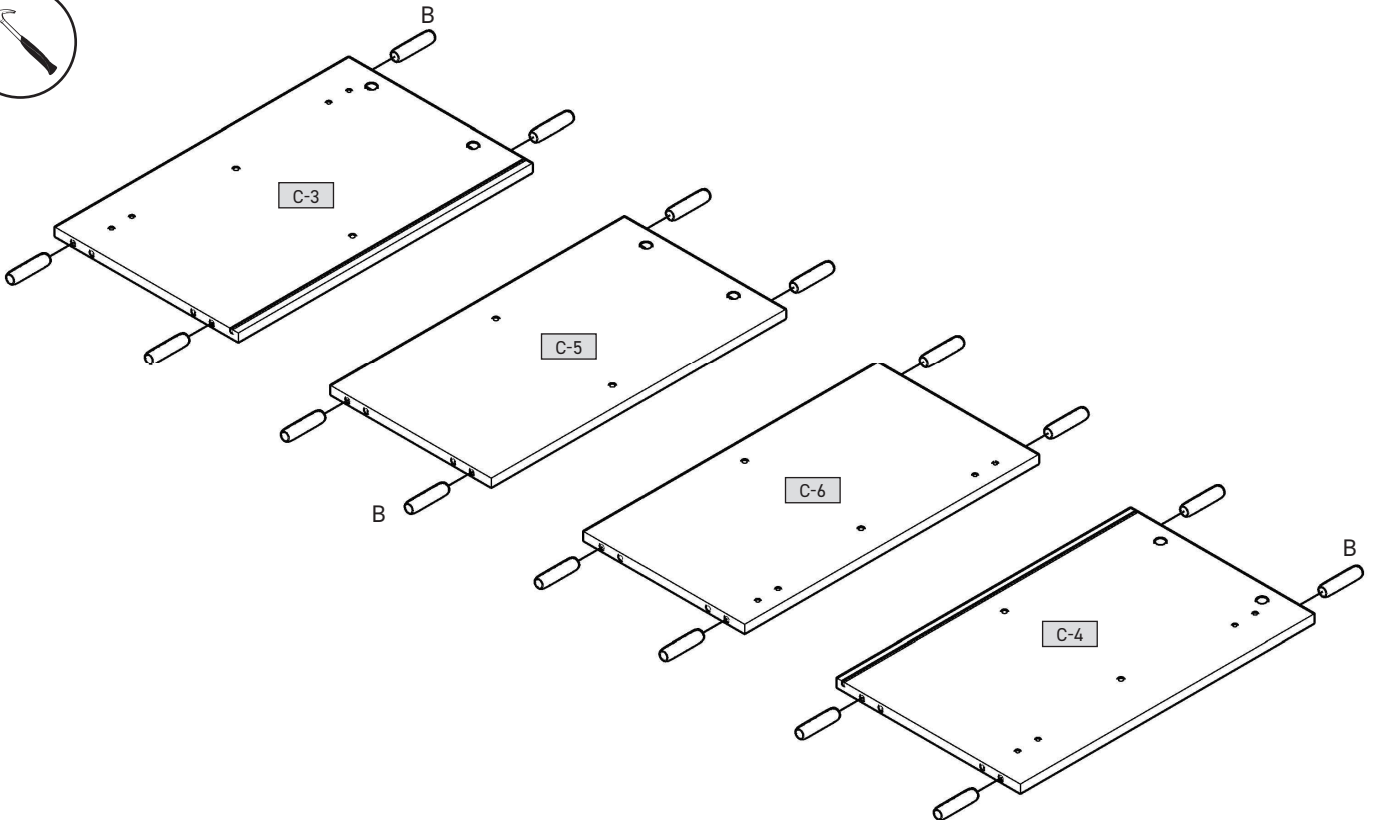
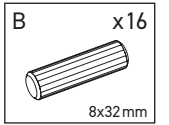

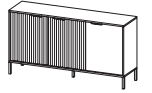

3

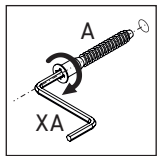
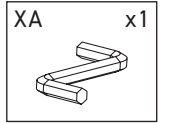
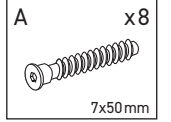
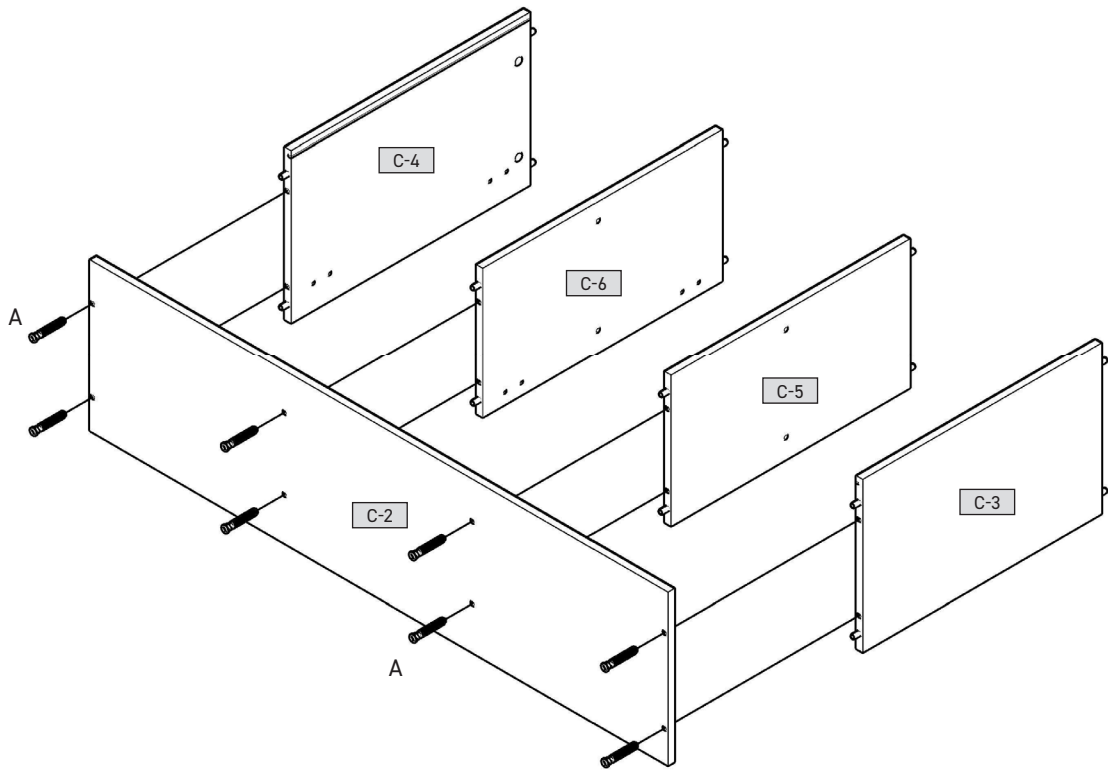

4

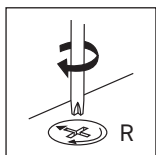
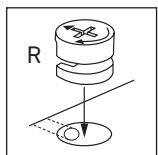
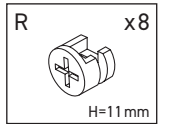
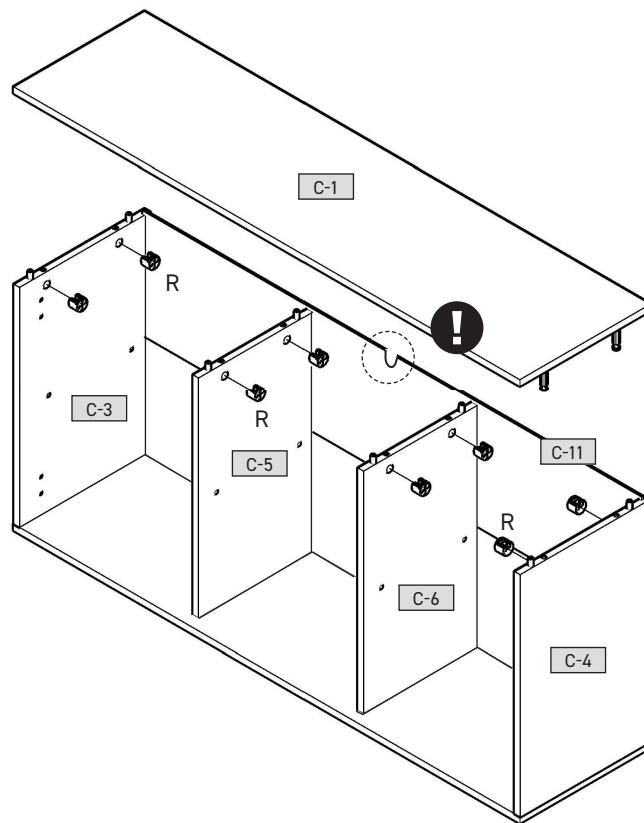

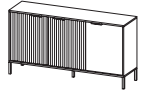

5

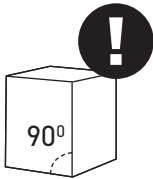
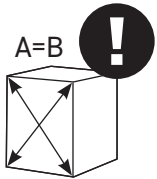
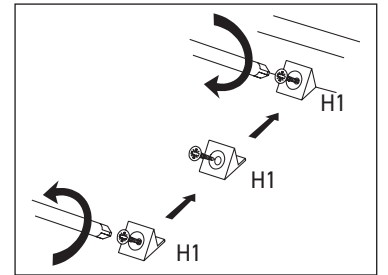
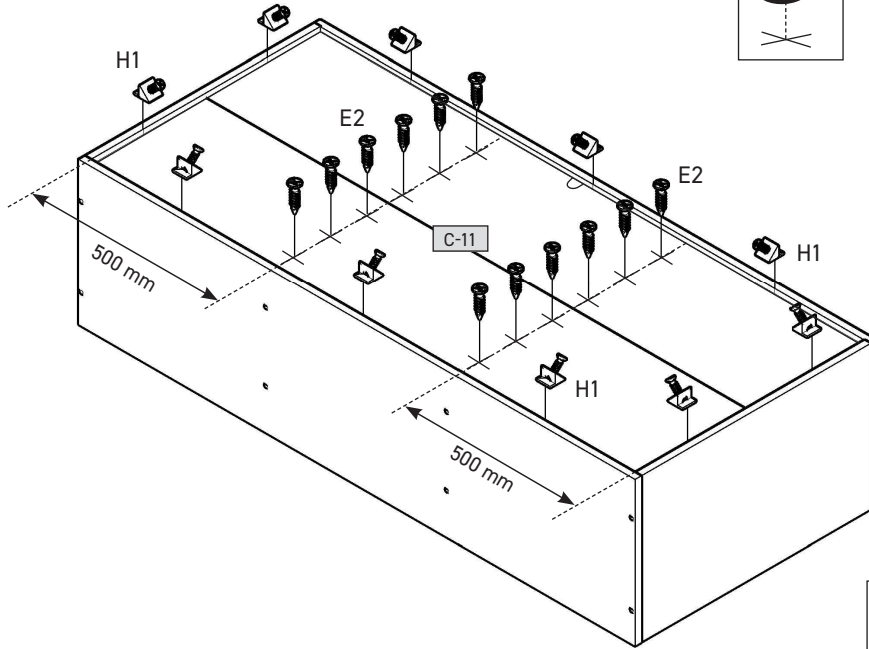
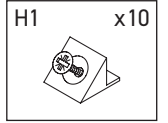
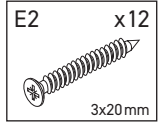
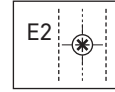
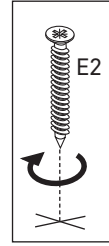

6

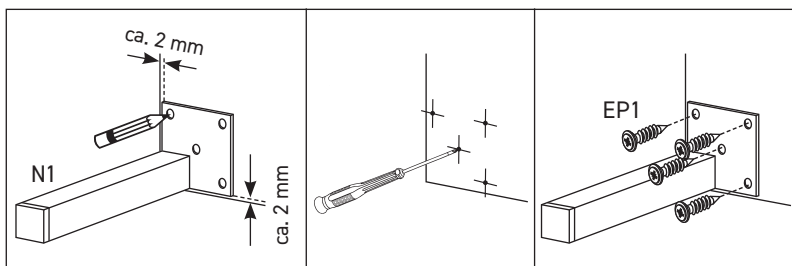
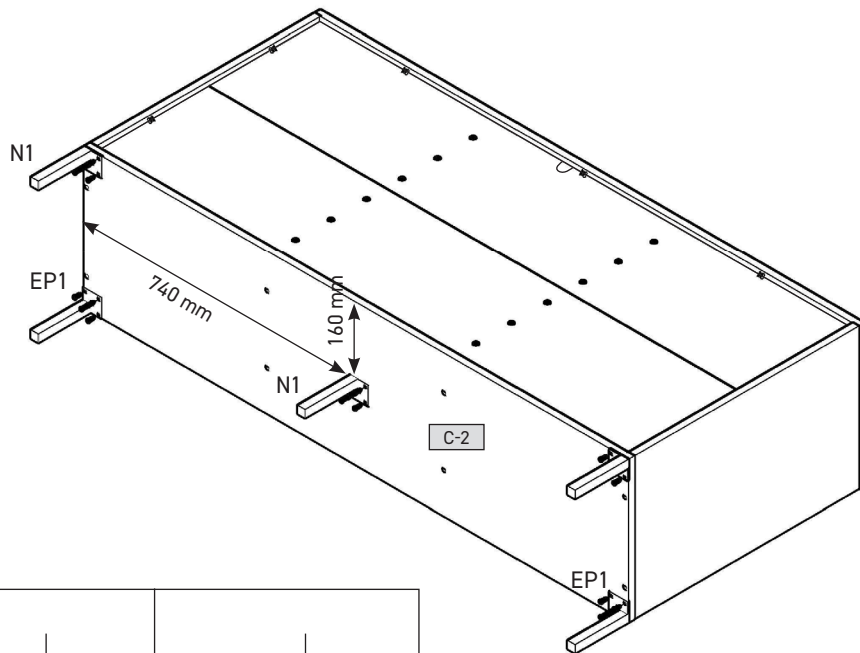
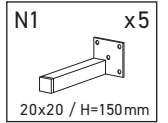
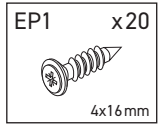

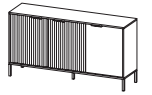

7

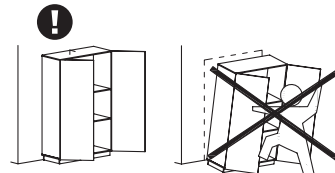
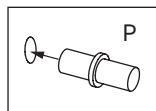
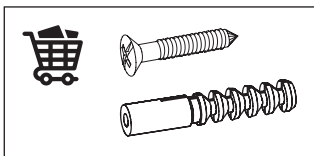
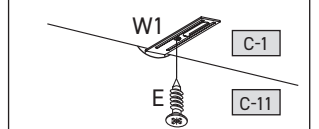
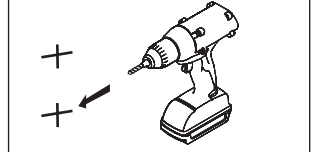
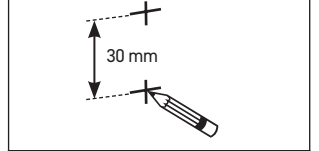
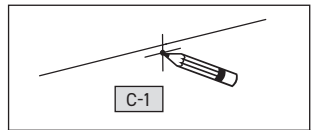
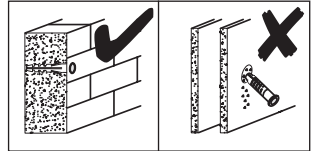
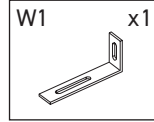
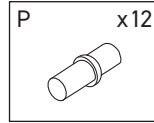
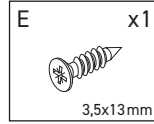
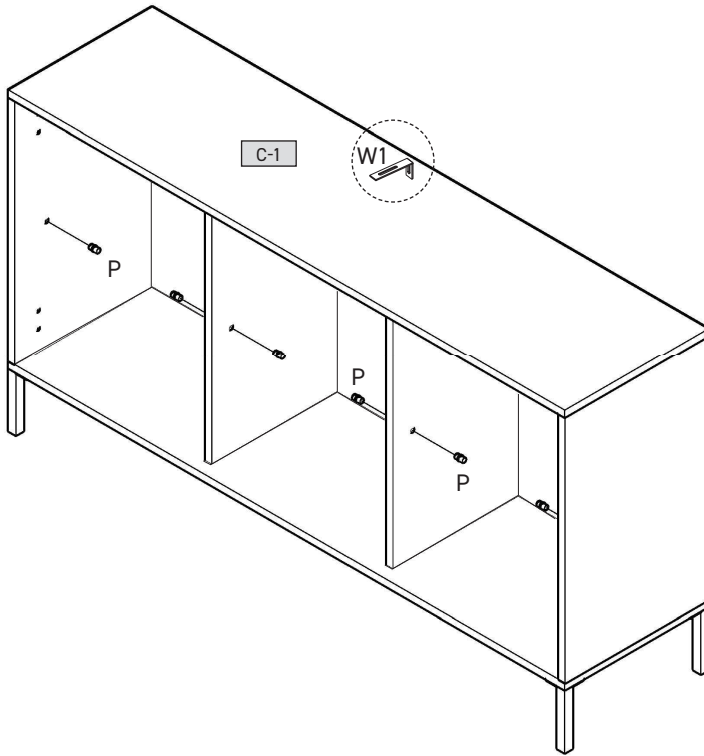

8

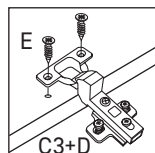
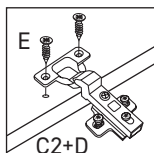
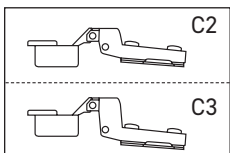
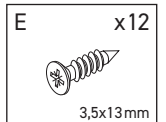
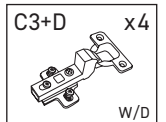
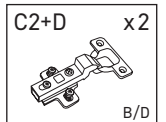
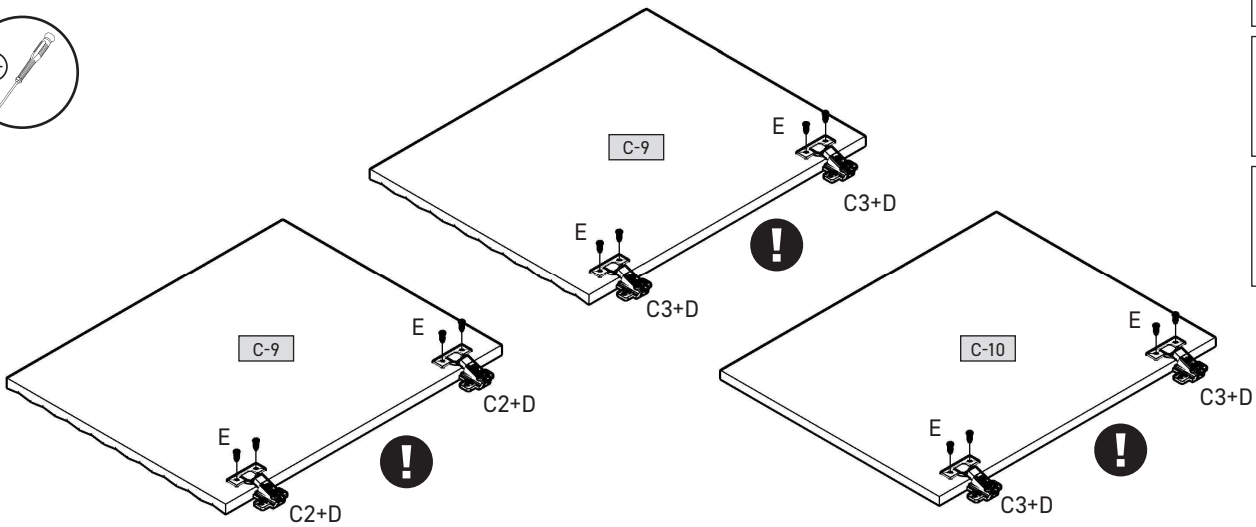

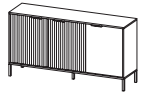



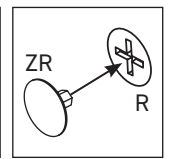
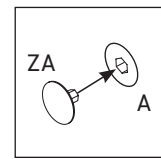
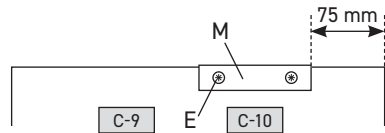
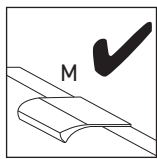
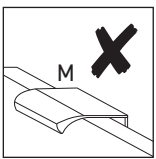
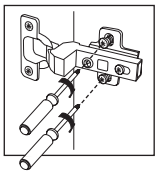
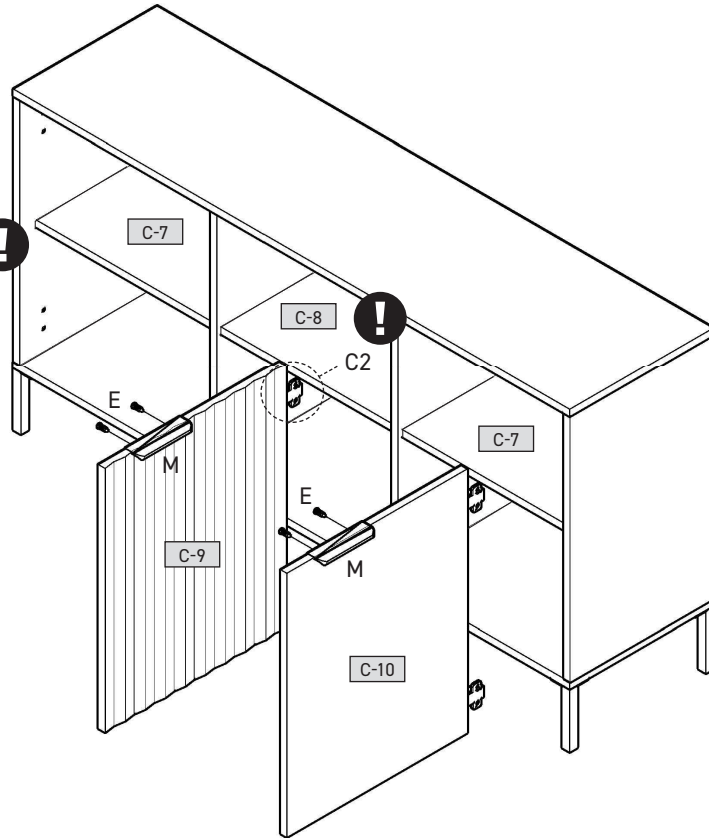
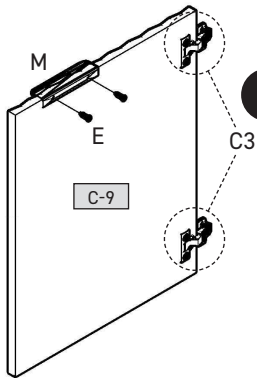
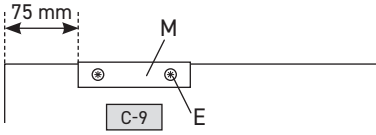
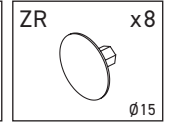
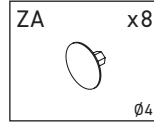
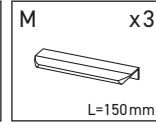
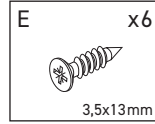



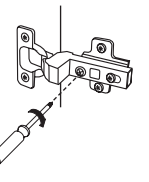
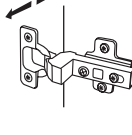
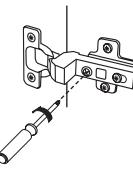
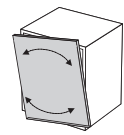
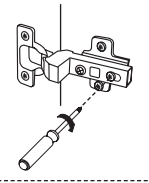
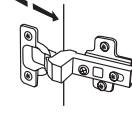
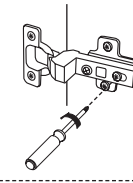
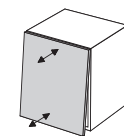
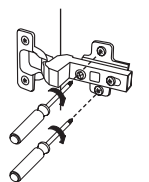
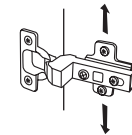
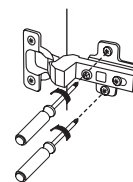
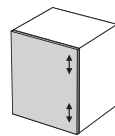
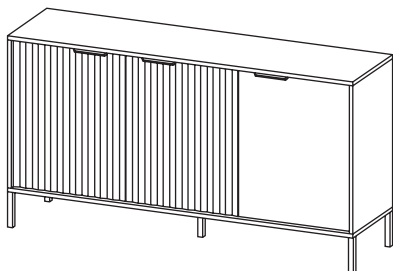

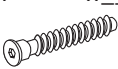

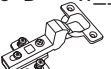

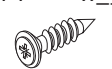

9

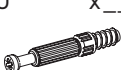

10



A x__  7x50mm	B x__  8x32mm	C2+D x__  B/D	C3+D x__  W/D	E x__  3,5x13mm	E2 x__  3x20mm	EP1 x__  4x16mm	H1 x__ 	M x__  L=150mm
N1 x__  20x20 / H=150mm	P x__ 	R x__  H=11mm	U x__  L=24,3mm	W1 x__ 	XA x__ 	ZA x__  Ø4	ZR x__  Ø15	

C-1	1531	395	16	x 1	1/2
C-2	1531	395	16	x 1	1/2
C-3	632	394	16	x 1	1/2
C-4	632	394	16	x 1	1/2
C-5	632	347	16	x 1	1/2
C-6	632	347	16	x 1	1/2
C-7	492	335	16	x 2	1/2
C-8	482	335	16	x 1	1/2
C-9	496	626	18	x 2	2/2
C-10	496	626	16	x 1	2/2
C-11	1512	646	3	x 1	1/2

